

BT-CSCF

Female Catheterization Training Model

USER'S GUIDE

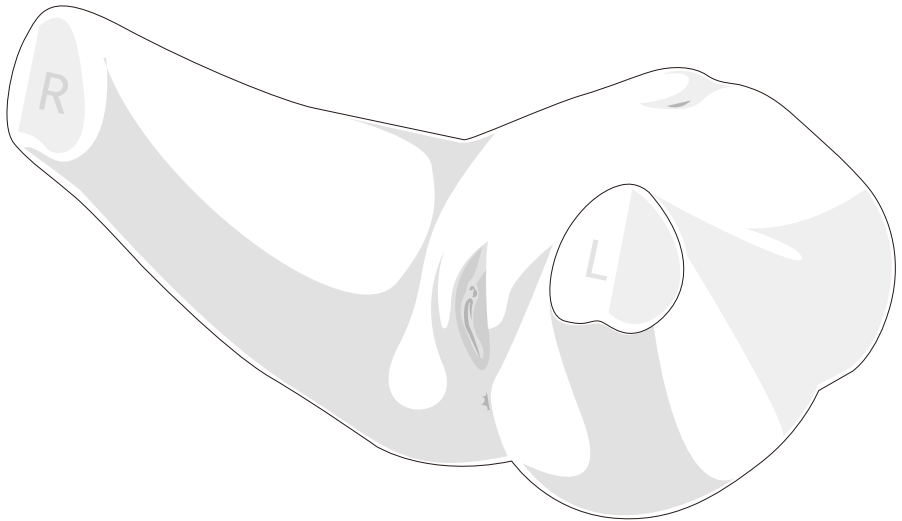

■ 제품 정보

제품명	여성 도노 훈련모형
모델명	BT-CSCF
제조사	주식회사 비티
제조국	대한민국

■ 제품 사양

크 기	성인둔부모형 : 430 x 280 x 200 mm 연장다리모형(좌/우) : 각 320 x 170 x 150 mm
무 게	성인둔부모형 : 3.5kg 연장다리모형(좌/우) : 각 1kg
사용 배터리	6LR61:1개 (9V)

■ 제품 서비스 문의

홈페이지	www.btinc.co.kr
주 소	본사 : 경기도 고양시 덕양구 통일로 140, A동 313호 영업/판매 : 부산광역시 남구 전포대로 92번길 27, 부산빌딩 5층
연 락 처	본사 : 02-2038-2903 영업/판매 : 051-903-1144
E-mail	bt@btinc.co.kr



■ 배터리 폐기 시 주의사항

사용한 배터리를 폐기할 때는 해당 지역의 관련 규정에 따르십시오.

Product Information

Product Name	Female Catheterization Training Model
Model Name	BT-CSCF
Manufacturer	BT Inc.
Country of Origin	South Korea
Certification	  RoHS

Product Specifications

Size	Adult buttocks model : 430 x 280 x 200 mm Extension legs (Left/Right) : 320 x 170 x 150 mm/each
Weight	Adult buttocks model : 3.5kg Extension legs (Left/Right) : 1kg/each
Battery	1EA of 6LR61 (9V)

Customer Service

Web-site	www.btinc.co.kr
Address	Headquarter : A-313 Samsong Techno-valley, 140, Tongil-ro, Deogyang-gu, Goyang-si, Gyeonggi-do, 10594, South Korea Sales : Busan Building 5F, 27, Jeonpo-daero 92beon-gil, Nam-gu, Busan 48404, South Korea
Contacts	Headquarter : +82-2-2038-2903 Sales : +82-51-903-1144
E-mail	bt@btinc.co.kr



Cautions for battery disposal

Please follow the regulations of corresponding area for the disposal of used batteries.

■ Cautions

Please read it carefully to ensure correct usage and user's safety through understanding of the product.

- ① Use only components provided or approved by BT Inc.
- ② Do not use the product for other purposes described in the manual.
- ③ If you disassemble or modify the product without any permission by BT Inc, you cannot get the warranty. Also, making imitated or altered products for commercial purposes are prohibited by law.
- ④ In case of burning smell or overheating, please contact us after removing battery.
- ⑤ Keep the product away from water and moisture.
- ⑥ Do not use the product near strong magnetic fields or high voltage power lines.
- ⑦ The product may malfunction under the extreme weather conditions.
(Operation temperature : 0°C~40°C (32°F~104°F), Storage temperature : -10°C~50°C (14°F~122°F))
- ⑧ Do not keep the product near hot or cold environments as possible. Deterioration of product or internal damage may occur by the extreme weather conditions
- ⑨ Never clean the product with chemicals such as solvent, benzene or thinner as these may cause fire ignition or the surface deterioration.
- ⑩ BT Inc. can change or adjust the product specification without any notice in order to improve the product.

Components



Female external genitalia model

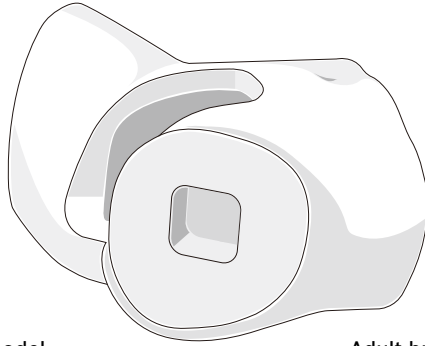

Adult buttocks model

Vaginal opening

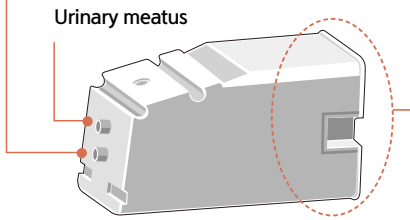

Urinary meatus

Internal genitalia module

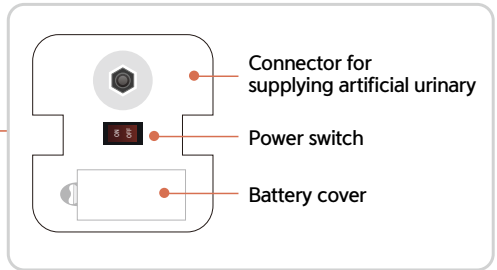

Connector for supplying artificial urinary

Power switch

Battery cover

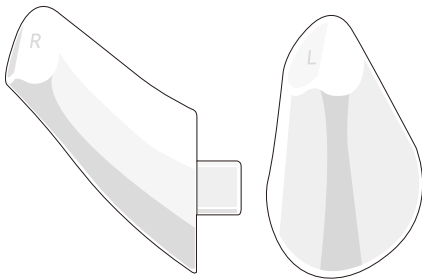

Extension legs
(Left/Right)

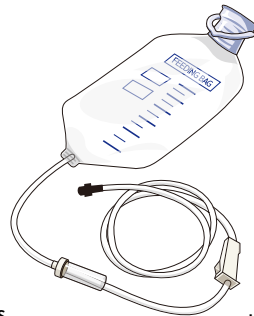

Urinary supply bag

* Etc. – Storage bag, User manual

Installation

<Install female catheterization training model>

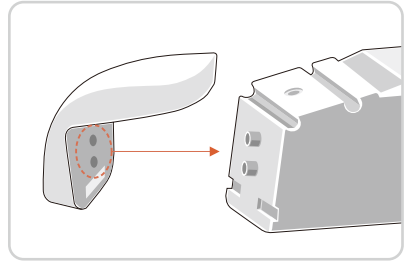
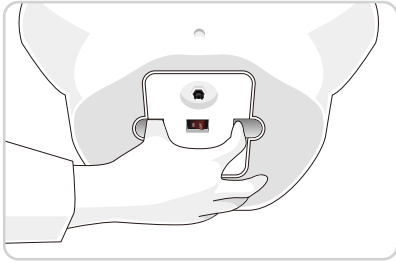
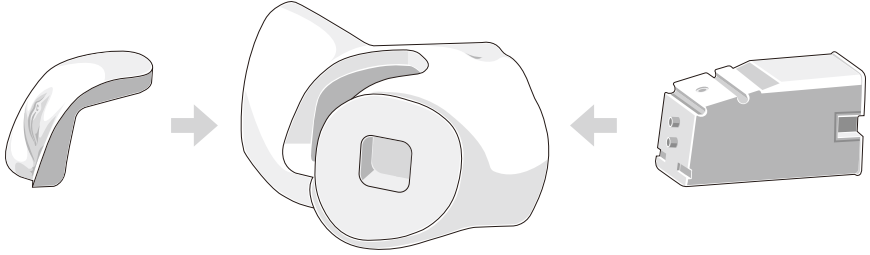

<Install extension legs>

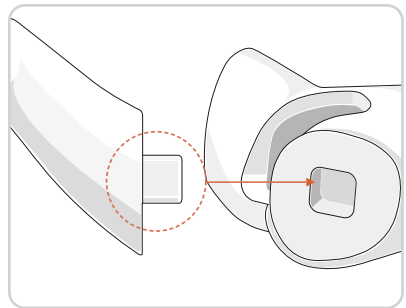
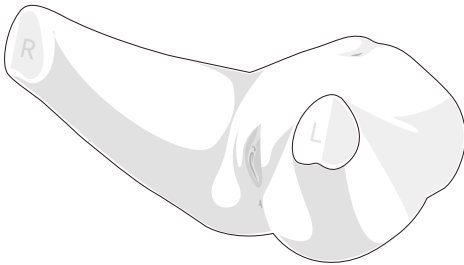

Installation

<Install urinary supply bag>

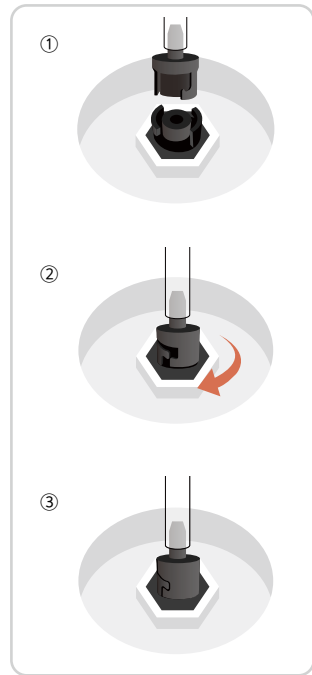
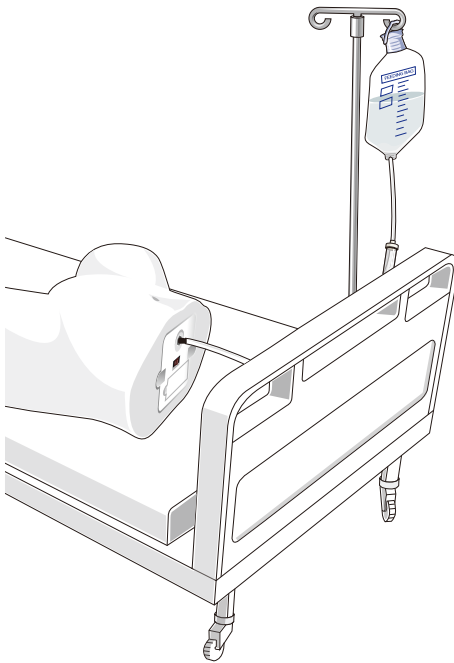

<Install battery>

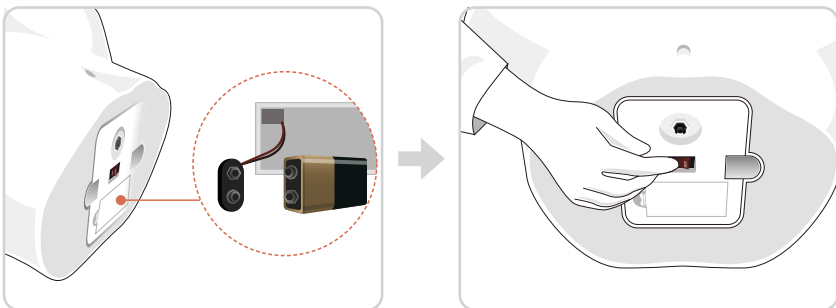

Turn the switch on after inserting a battery inside of the internal genitalia module.

* Please use a standard 6LR61 battery.

Functions

<Indwelling catheterization>

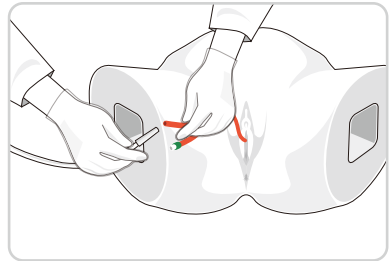
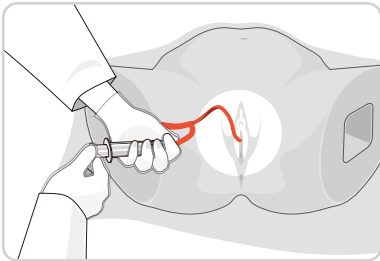
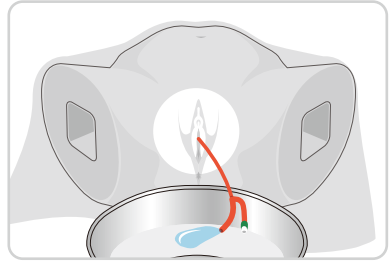
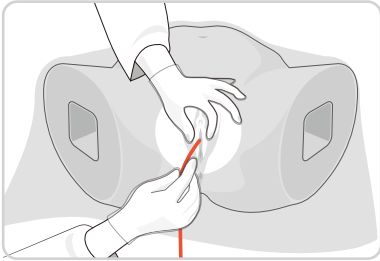
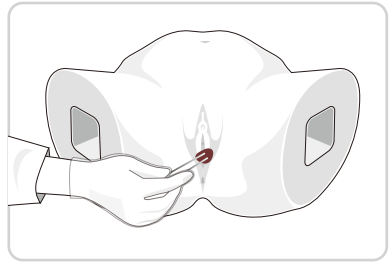
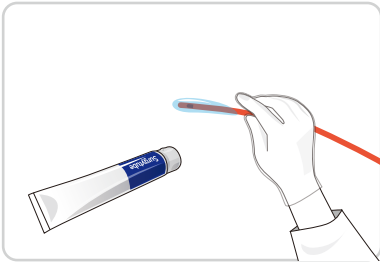

※ When practicing urination, be sure to apply enough lubricant to the catheter.

Functions

<Nelaton catheterization>

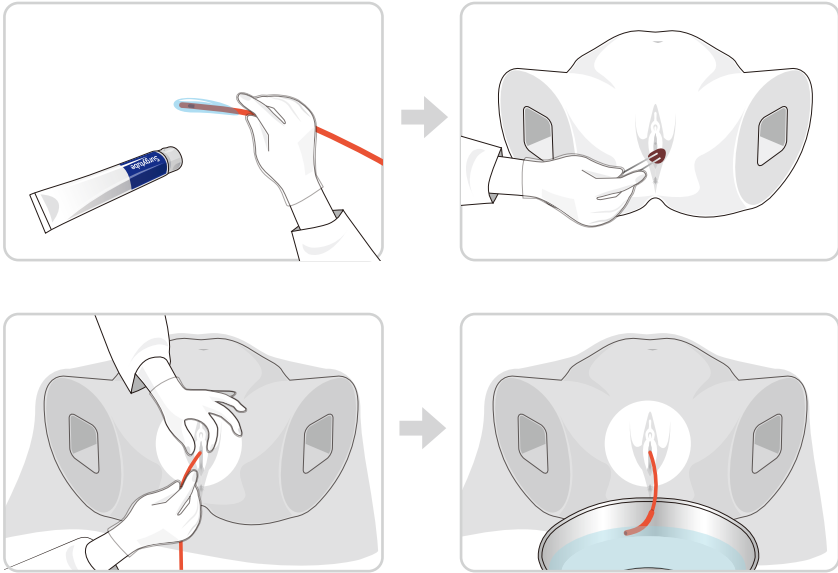

<Alarm sound when a catheter inserted into vagina>

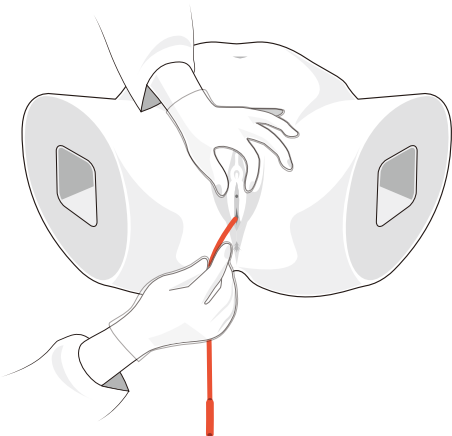

- ① Alarm alerts when a catheter inserted into vagina, not urethral meatus.
- ② Alarm stops when the inserted catheter is removed from vagina.
- ③ The alarm can be turned on/off with a power switch.

Maintenance

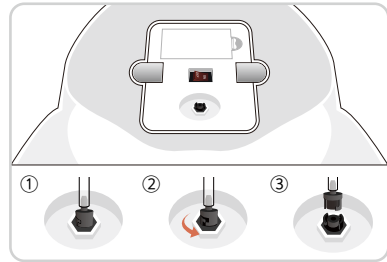
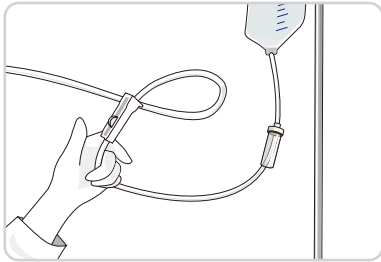

Close the roller clamp of urinary supply bag and remove the urinary supply bag after making the manikin stand.

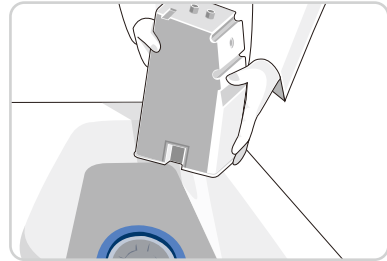
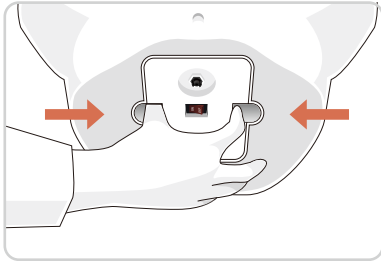

Turn the power off, take the internal genitalia module out with fingers and flush the left urinary out.

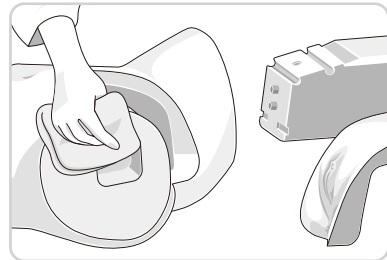
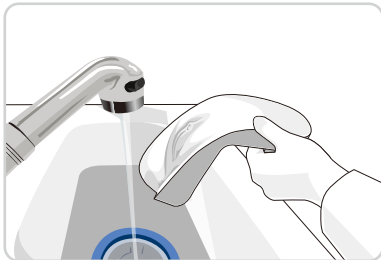

Wash the external genitalia model and wipe the moisture to make it dry for storage.

BT-CSCF

Female Catheterization Training Model

A-313, Samsung Techno-valley, 140, Tongil-ro,
Deogyang-gu, Goyang-si, Gyeonggi-do, 10594, Republic of Korea
Homepage: www.btinc.co.kr / E-mail: bt@btinc.co.kr
Tel: +82-2-2038-2903, +82-51-903-1144 / Fax: +82 303-3130-0607

Copyright(c) BT Inc. All rights reserved.